

# Cassina

## 553 BOWY-SOFA

Year of design **2018**

**Bowy-Sofa, absolute comfort in numerous combinable modules, featuring high-quality tailoring by Cassina.**

**Experiment with the sofa modules for a versatile design.**

*Bowy-Sofa* is a modular sofa with soft and welcoming curves that can be composed in a playful way.

Its characteristic shape features a rounded armrest that directly meets the backrest which then emerges beyond the seat units. Circular, semi-circular and rectangular shapes alternate dynamically to create a play of volumes and a graphic silhouette.

*Bowy-Sofa* is a ground sofa, almost monolithic, and is made up of individual modules with various types of backrests and seats (central, end, corner and chaise-longue) that have been conceived as sculptural pieces to be used either alone or in a wide range of compositions.

**Precious details highlight its silhouette.**

Abounding in detail, this sofa is characterised by padded stitching that outlines the shape of the various elements. A tailoring challenge masterfully taken on by Cassina, thanks to the company's consolidated experience in working with fabrics. Even the corners of the backrest have been skilfully stitched like a *haute-couture* suit.

**The collection is completed with *Bowy-Table*.**

Patricia Urquiola completes the collection with a series of poufs and coffee tables. The *Bowy-Tables* feature the same rounded forms as the sofa and are available with a glossy lacquered finish inspired by the '70s or with a more textured wooden top. The tables can be overlapped and intersected to break away from the usual seating schemes.

Materials: fir plywood internal structure and tubular metal frame with elastic belting, padding in CFCfree expanded polyurethane foam in differentiated densities, inner lining in different gram weights of polyester wadding, upholstered with leathers and fabrics from the Cassina Collections.

# Gallery

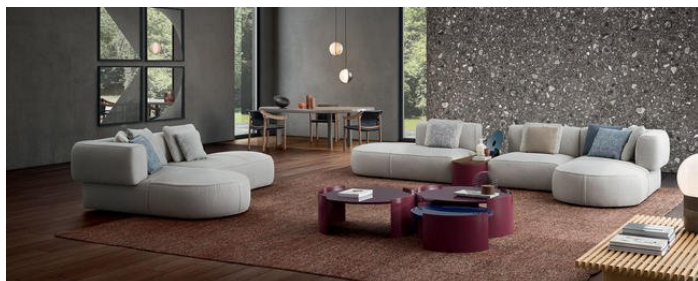

# Dimensions

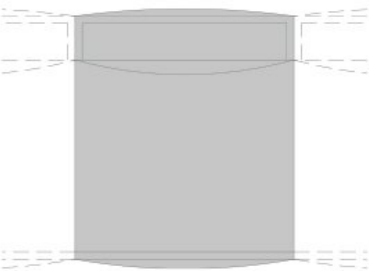
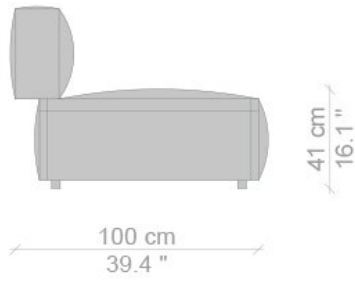
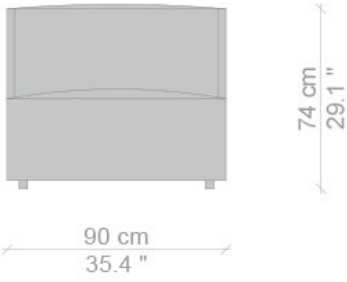
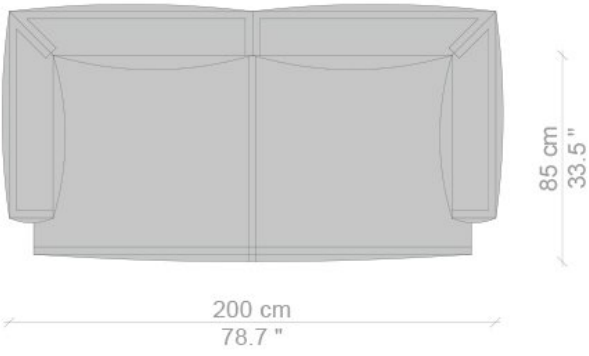
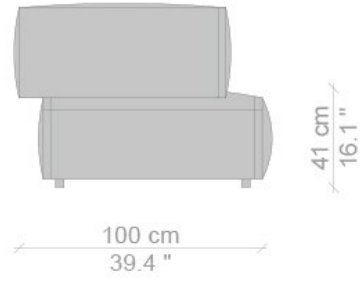
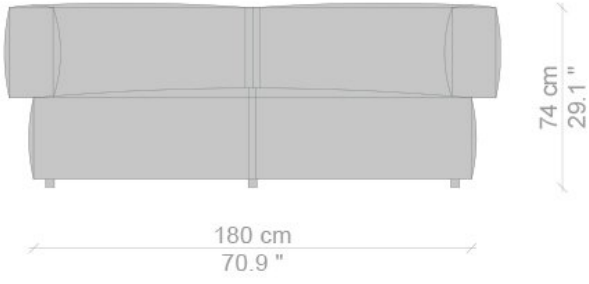

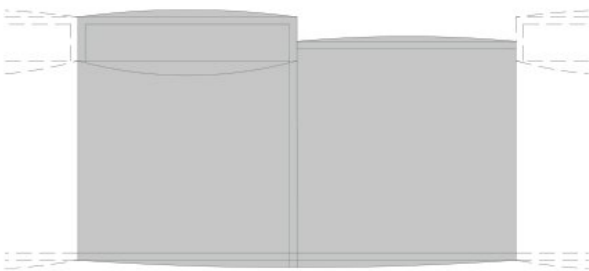
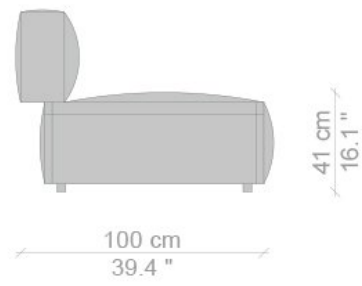
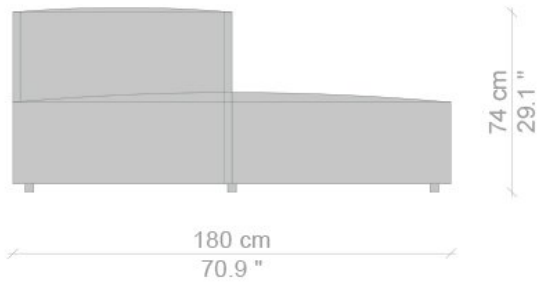
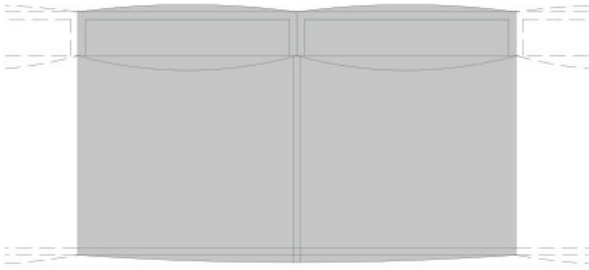
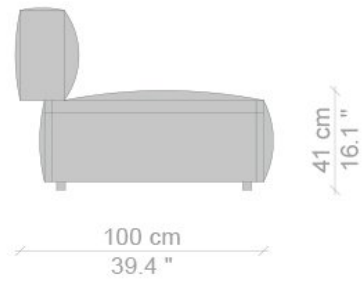
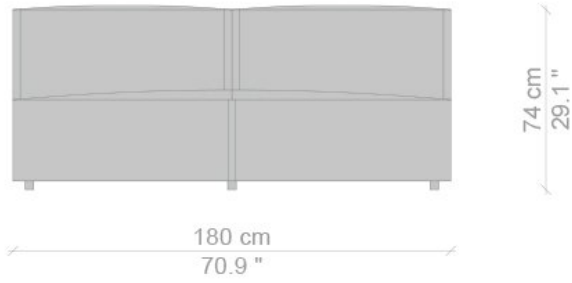

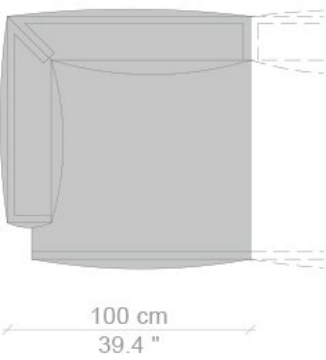
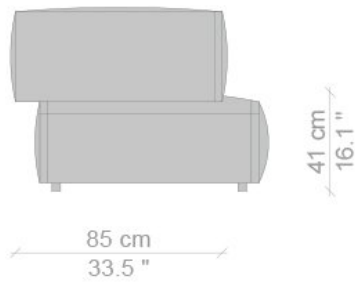
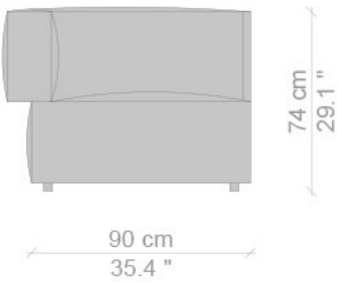
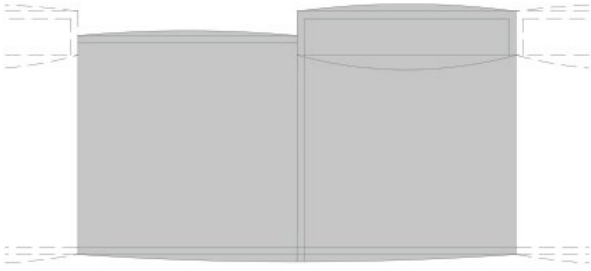
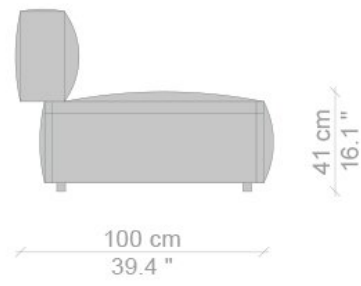
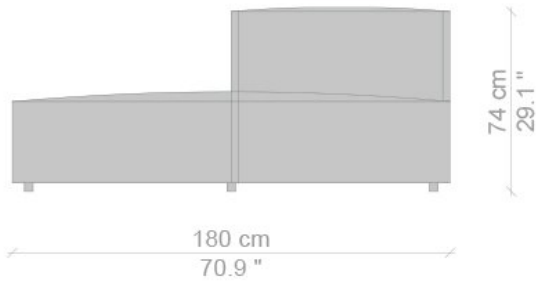

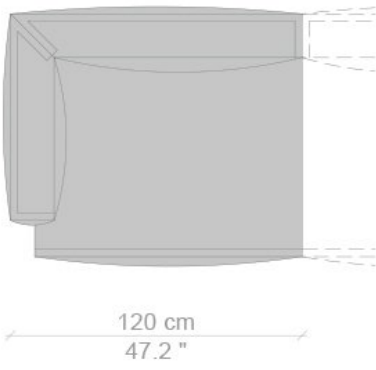
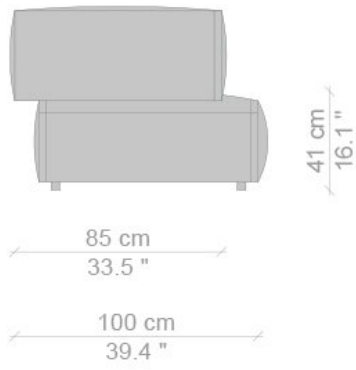
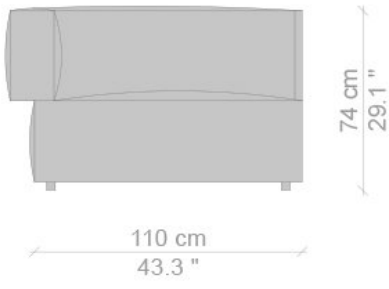

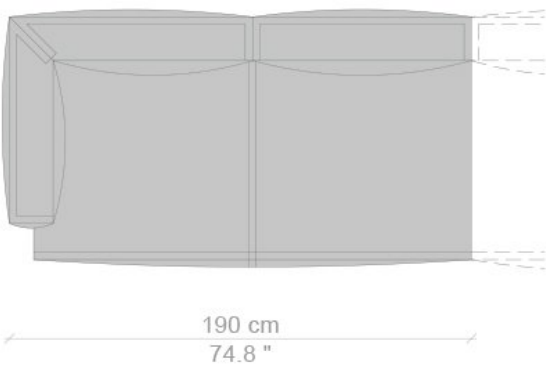
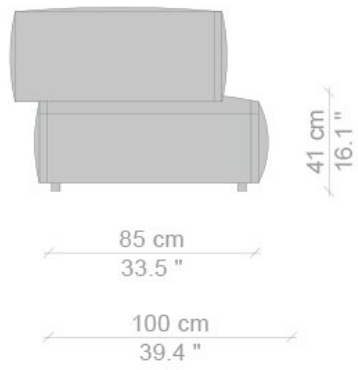
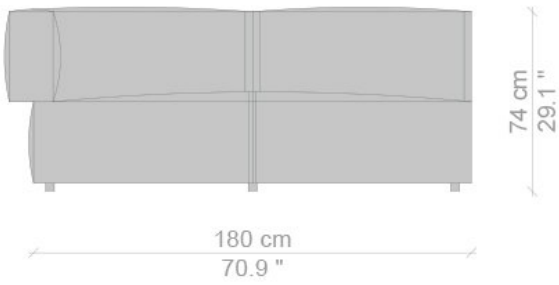

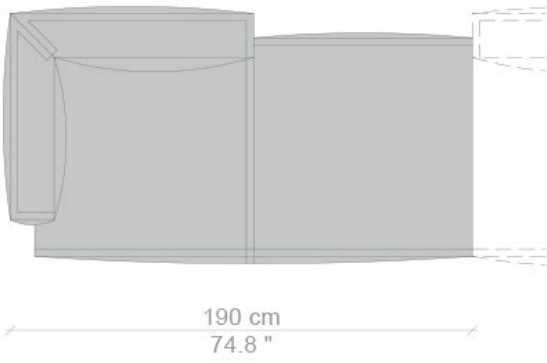
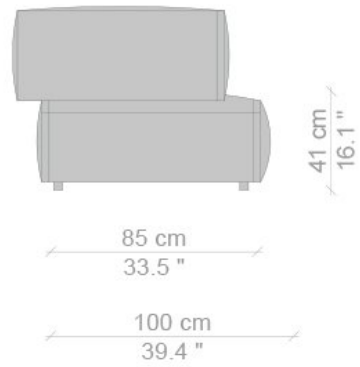
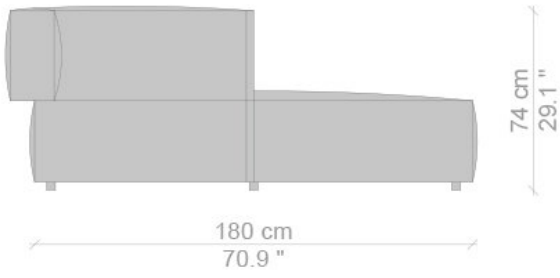



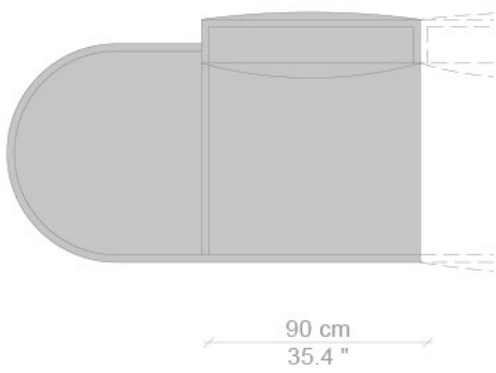
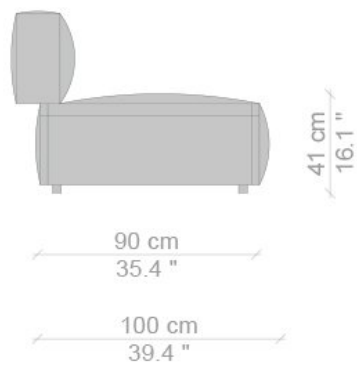
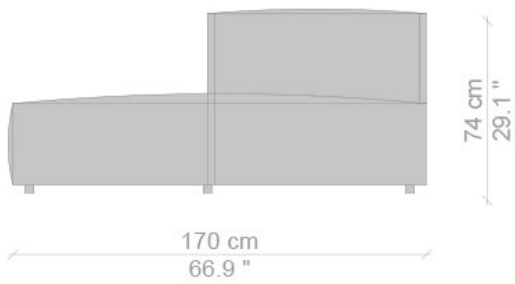

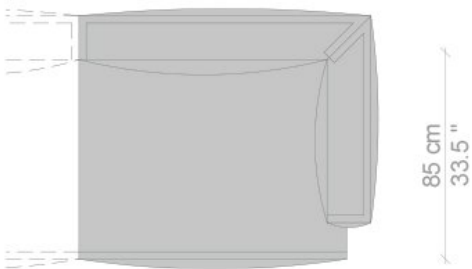
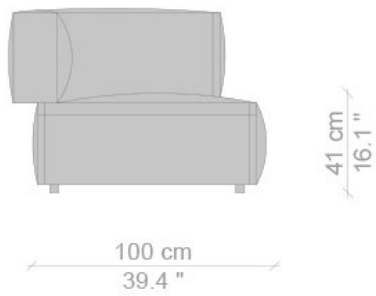
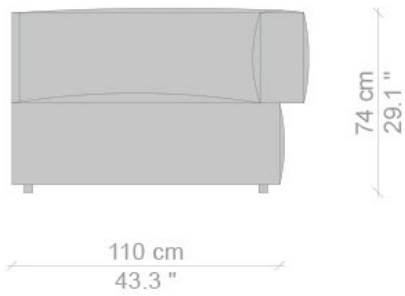
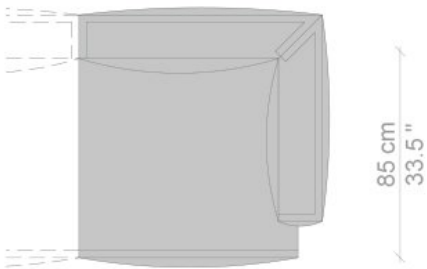
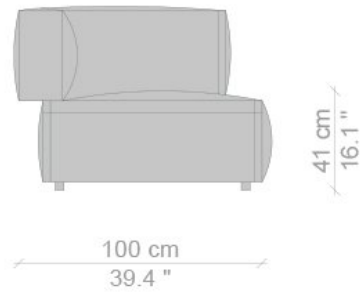
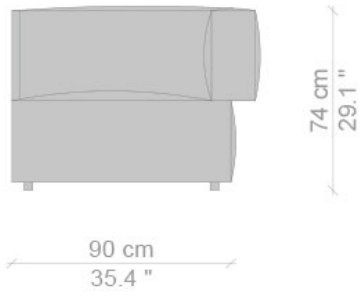

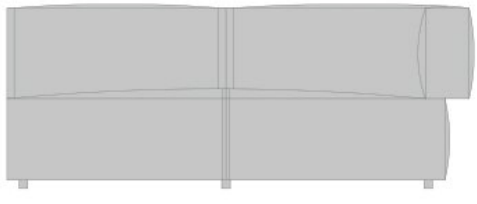

180 cm  
70.9 "

74 cm  
29.1 "

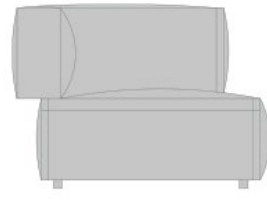

100 cm  
39.4 "

41 cm  
16.1 "

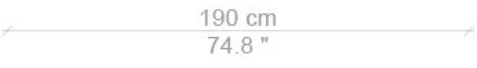

190 cm  
74.8 "

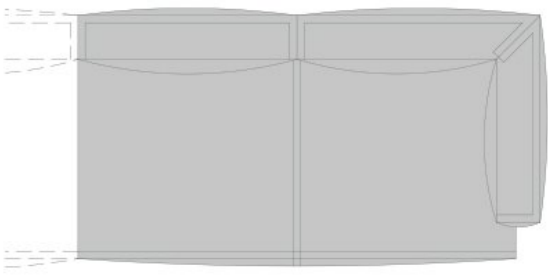

85 cm  
33.5 "

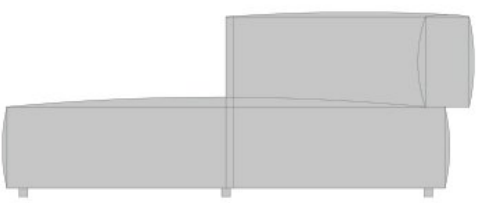

74 cm  
29.1 "

180 cm  
70.9 "



41 cm  
16.1 "

100 cm  
39.4 "

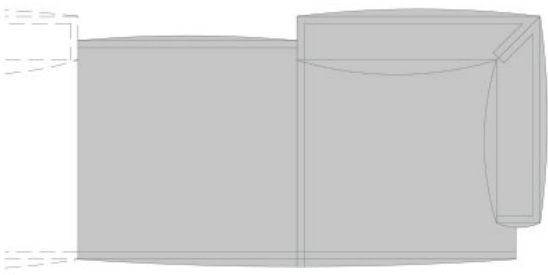

85 cm  
33.5 "

190 cm  
74.8 "

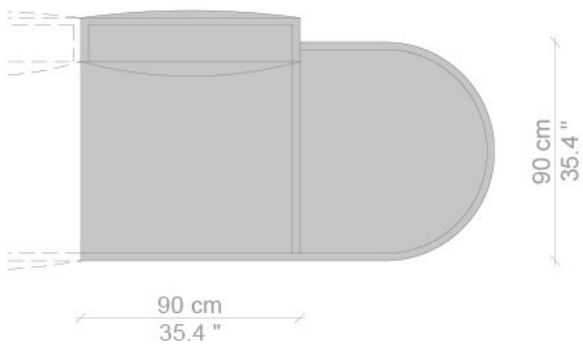
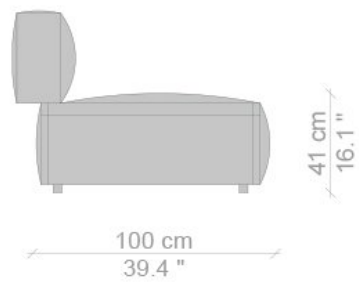
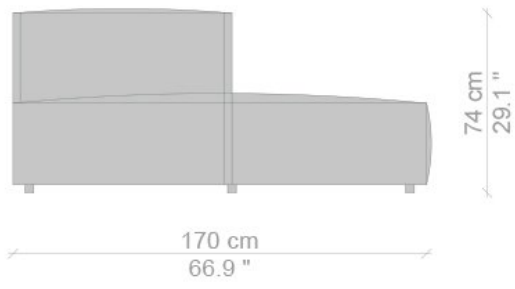

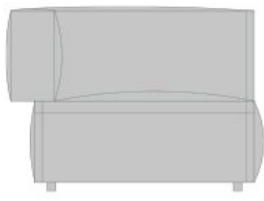

100 cm  
39.4 "

41 cm  
16.1 "

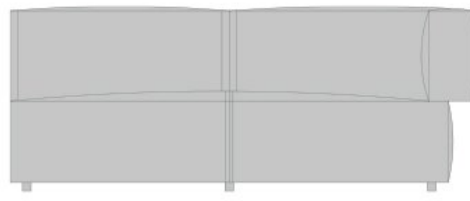

180 cm  
70.9 "

74 cm  
29.1 "

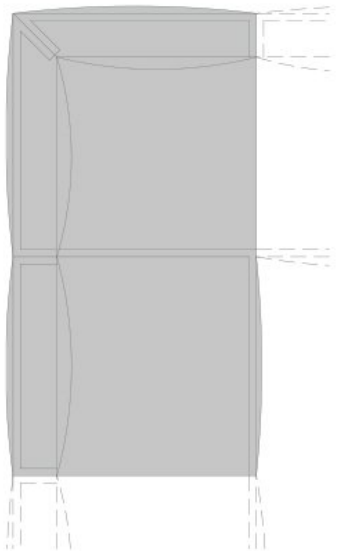

190 cm  
74.8 "

100 cm  
39.4 "

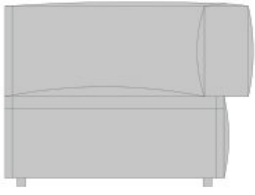

100 cm  
39.4 "

41 cm  
16.1 "

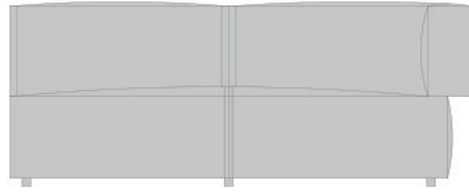

180 cm  
70.9 "

74 cm  
29.1 "

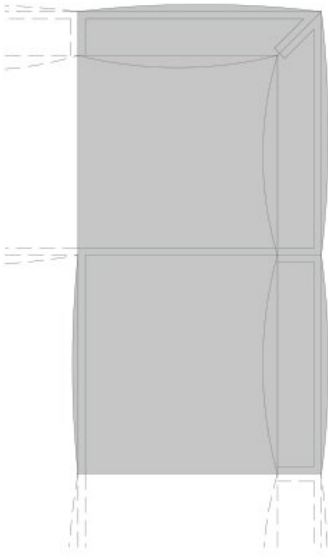

100 cm  
39.4 "

190 cm  
74.8 "

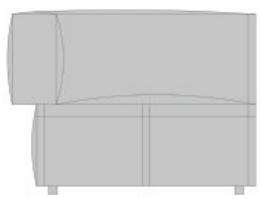

100 cm  
39.4 "

41 cm  
16.1 "

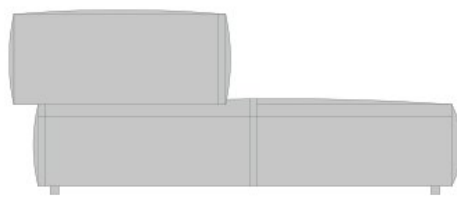

85 cm  
33.5 "

74 cm  
29.1 "

180 cm  
70.9 "

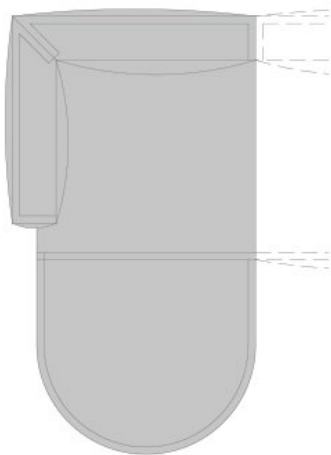

90 cm  
35.4 "

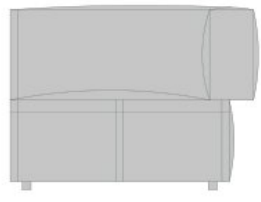

100 cm  
39.4 "

41 cm  
16.1 "

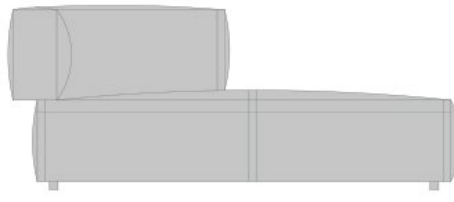

85 cm  
33.5 "

74 cm  
29.1 "

180 cm  
70.9 "

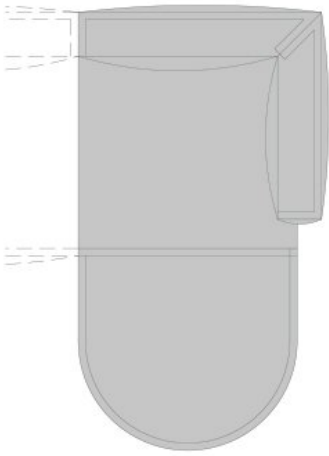

90 cm  
35.4 "



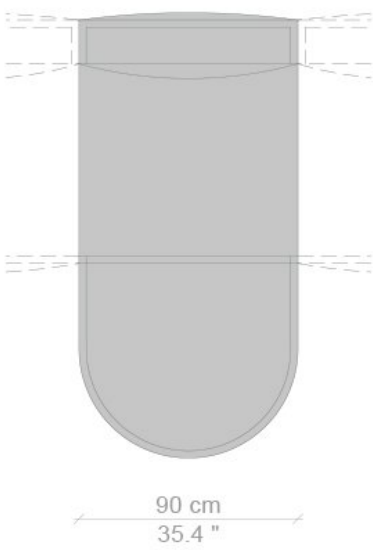
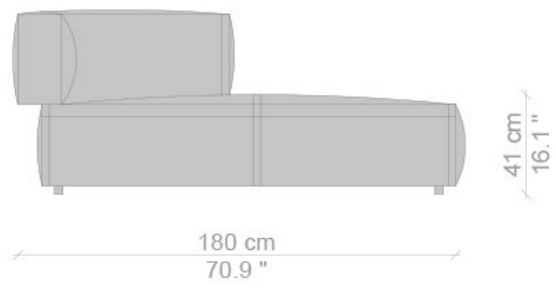
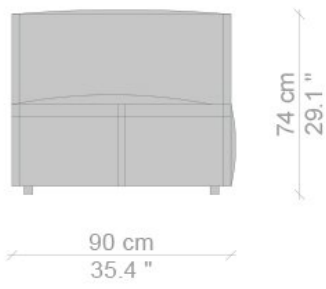

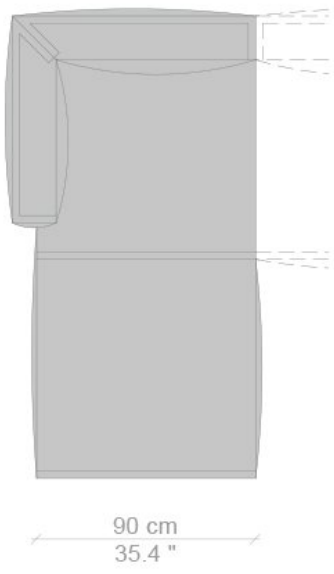
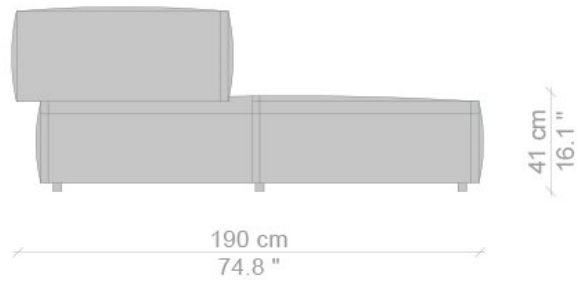
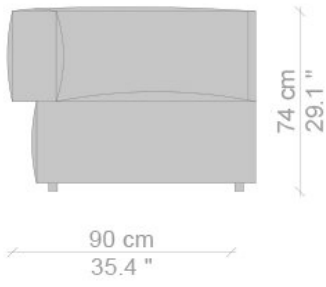

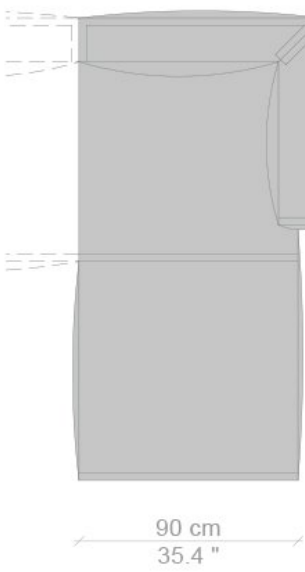
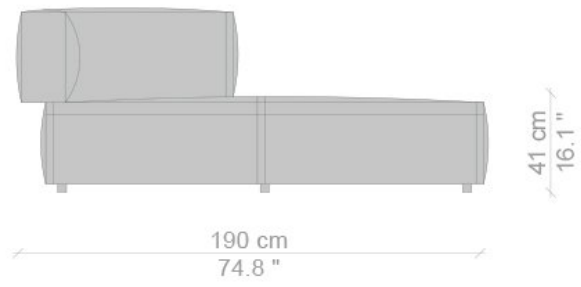
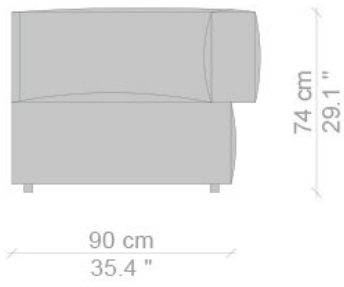



41 cm  
16.2 "

90 cm  
35.4 "



90 cm  
35.4 "

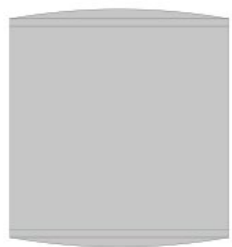

41 cm  
16.2 "

110 cm  
43.3 "



90 cm  
35.4 "



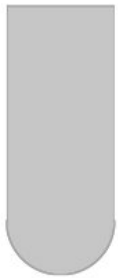
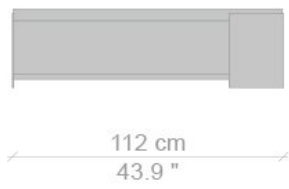
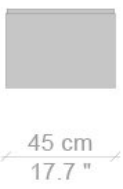
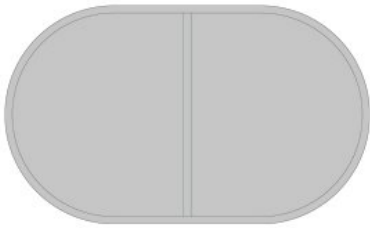
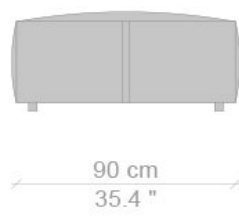
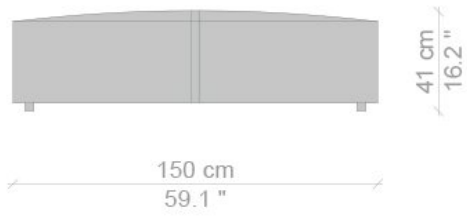

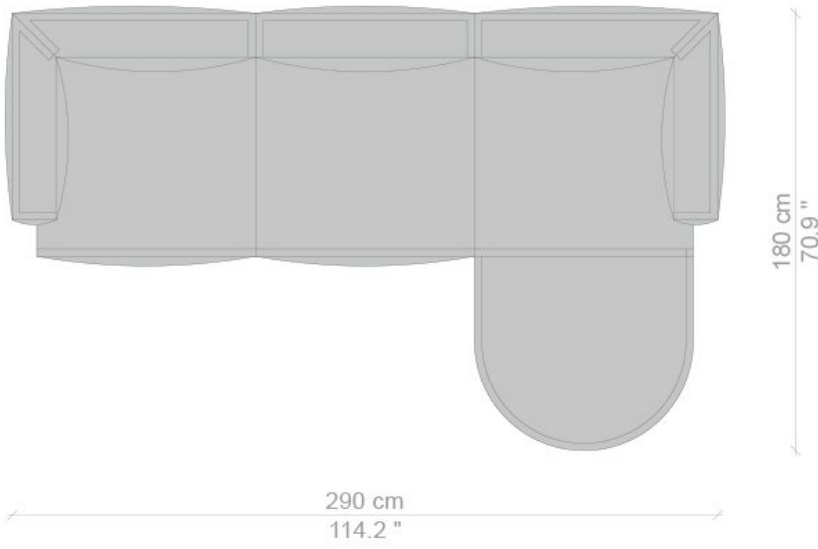
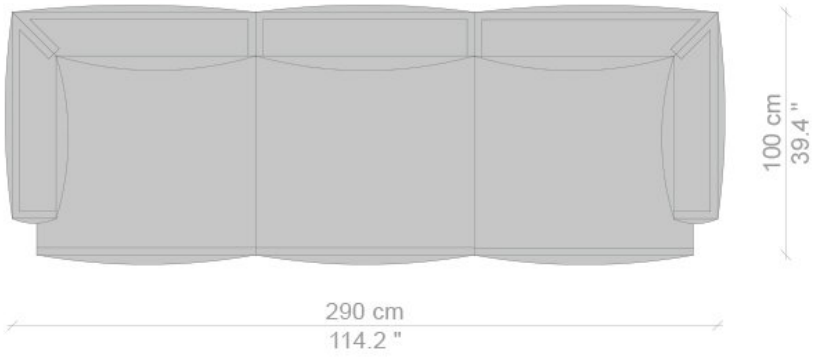

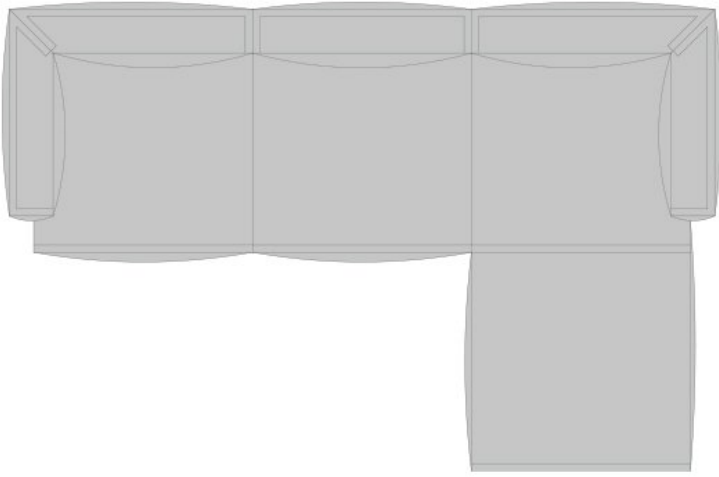

190 cm  
74.8 "

290 cm  
114.2 "

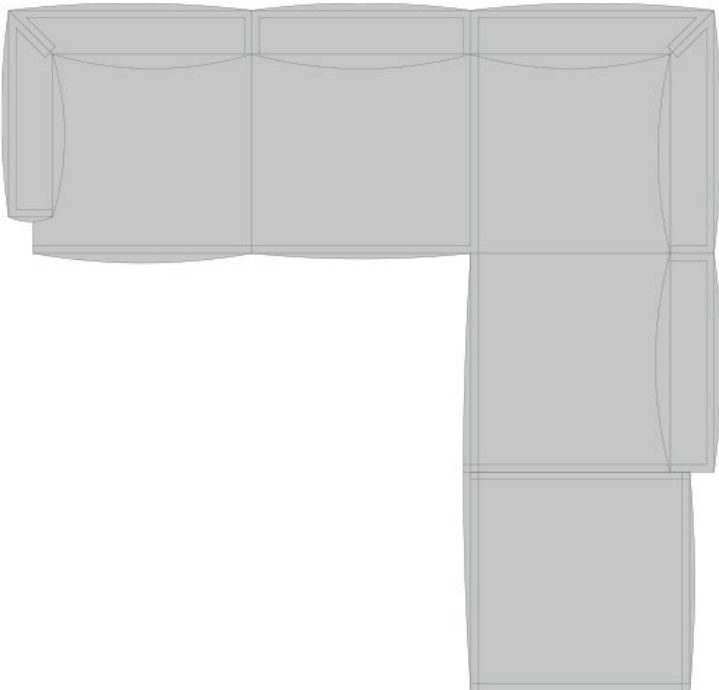

100 cm  
39.4 "

280 cm  
110.2 "

290 cm  
114.2 "

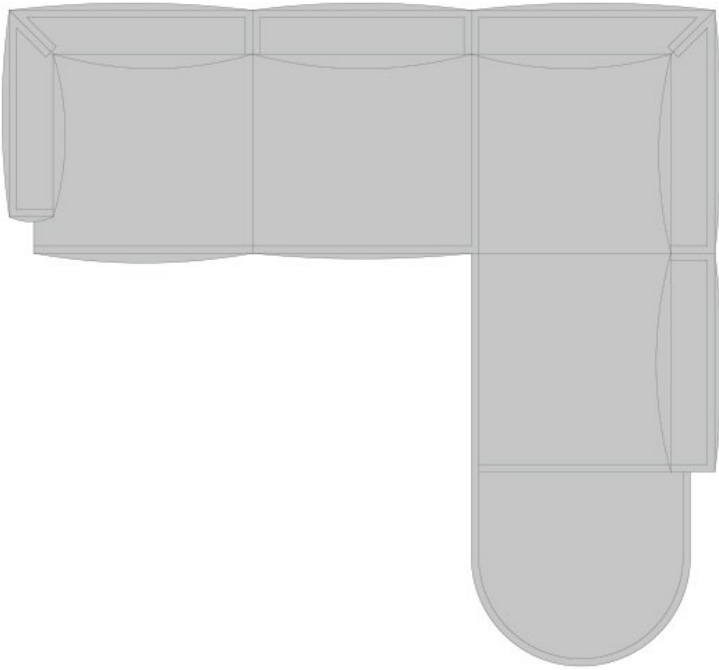

100 cm  
39.4"

270 cm  
106.3"

290 cm  
114.2"

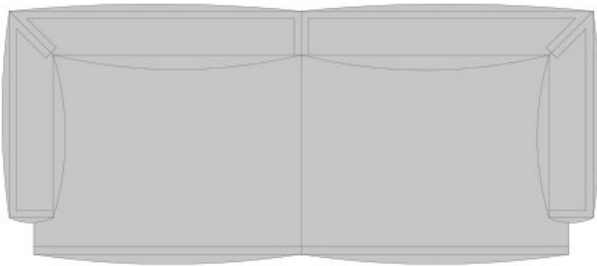

100 cm  
39.4"

240 cm  
94.5"



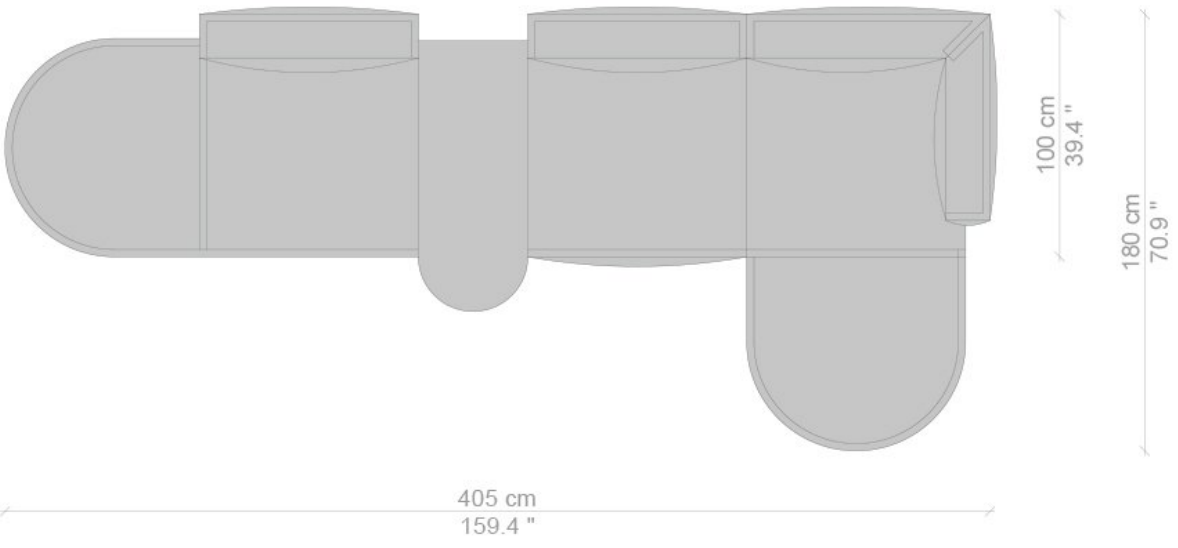
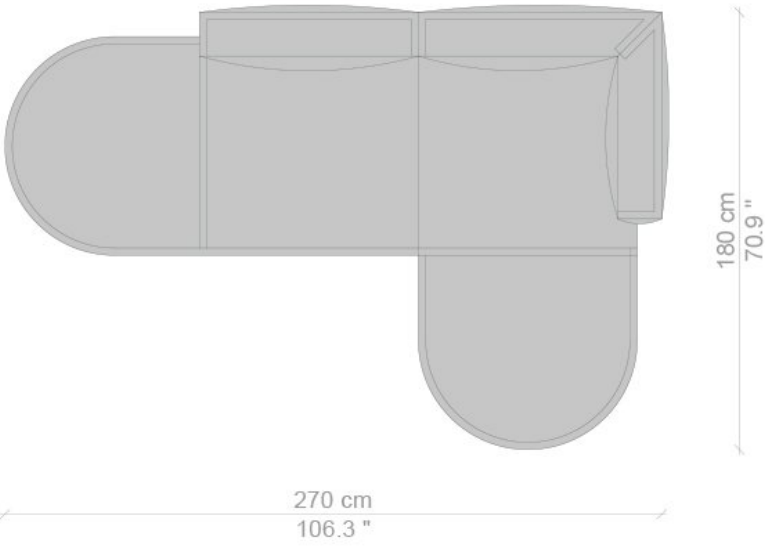

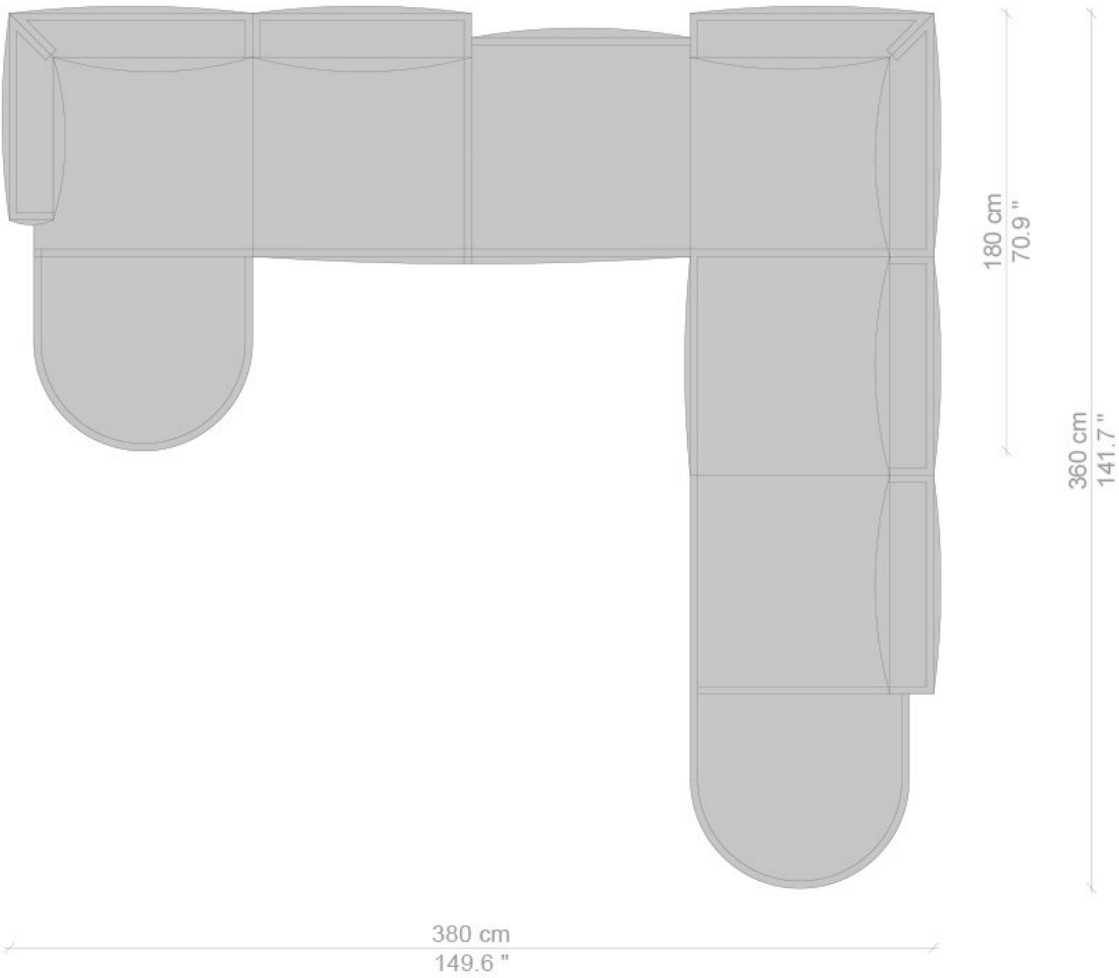
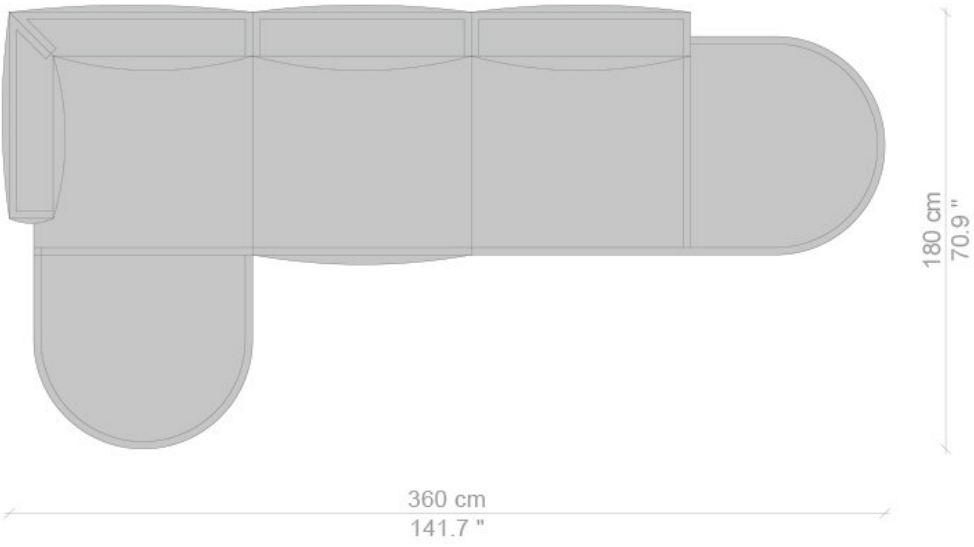

## Designer



**Patricia Urquiola**

*Patricia Urquiola was born in Oviedo (Spain) in 1961. Lives and works in Milan. She attended the University of Architecture at Madrid Polytechnic and Milan Polytechnic, where she graduated in 1989 with Achille Castiglioni. Assistant lecturer to Achille Castiglioni and Eugenio Bettinelli in Milan and Paris, responsible for the new product development office of DePadova, working with Vico Magistretti, head of Lissoni Associati's design group. In 2001 she opened her own studio working on product design, architecture, and installations. Amongst her last projects of architecture: The museum of Jewel in Vicenza, Mandarin Oriental Hotel in Barcelona, das Stue Hotel in Berlin and the Spa of Four Seasons Hotel in Milan; showroom and installations for Gianvito Rossi, BMW, Cassina, Missoni, Moroso, Molteni, Officine Panerai, H&M, Santoni and the general concept of Pitti Immagine Firenze. She realize design products for the most important Italian and international companies, such as : Agape, Alessi, Axor-Hansgrohe, B&B Italia, Baccarat, Boffi, Budri, De Padova, Driade, Ferragamo, Flos, Gan, Georg Jensen, Glas Italia, Haworth, Kartell, Kettal, Kvadrat, Listone Giordano, Louis Vuitton, Molteni, Moroso, Mutina, Rosenthal and Verywood. Some of her products are exposed in various Museums and collections, such as MoMA in New York, Les arts decoratifs in Paris, the Museum of Design in Zurich, Vitra Design Museum in Basel, Victorian&Albert Museum in London, Stedelijk in Amsterdam and Triennale Museum in Milan. She has won several international prizes and awards. Amongst others the Medalla de Oro al Mérito en las Bellas Artes (Gold Medal of fine arts) awarded by the Spanish Government; Order of Isabella the Catholic, awarded by His Majesty The King of Spain Juan Carlos I; "Designer of the decade" for two German magazines, Home and Häuser, "Designer of the Year" for Wallpaper, Ad Spain, Elle Decor International and Architektur und Wohnen Magazine. She is Ambassador of Expo Milano 2015. September 2015 Patricia Urquiola nominated Art Director of Cassina.*