

MINIMA 3.0

(Designer Bruno Fattorini & Partners)

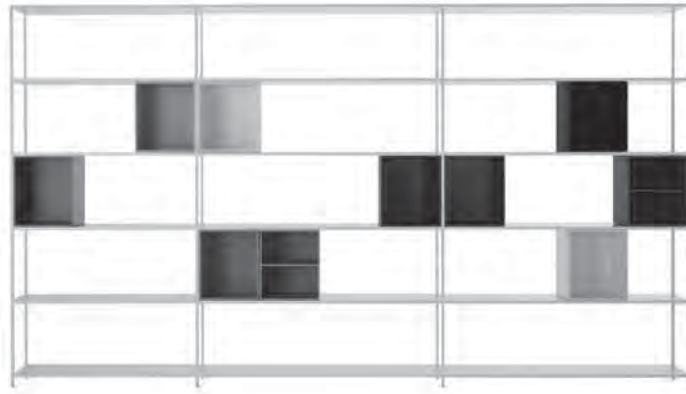

Minima 3.0: three stands for the three key elements that compose the system: shelf, frame, cabinets.

Essential and flexible, Minima 3.0 represents the natural makeover of Minima, MDF Italia collection's icon product, special mention at the XVII Compasso D'Oro ADI in 1998. Technology and innovation have enabled this thin aluminium structure that is 15 mm thick only, to propose an increasingly minimal yet strong identity. The considerable span of the shelf in extruded aluminium combined with the joining system, have allowed to develop the system in length, making it modern and adjustable to any kind of environment: home, office, community areas, contract....

Modular and flexible even thanks to the new kinds of storage units.

This can be with open, door, flap opening doors or drawers. They are simply resting inside the structure and are repositionable quite easily, thus allowing to meet any storage requirements as desired and to choose your own style of living by using different colours, woods and shapes.

Black or white, lacquered or in wood, essential or multicoloured, linear or monolithic, these are Minima's many variables, a real modular structure archetype.

Structure

Uprights and shelves made of extruded aluminium and assembled together by using a concealed joining system, capable of giving the structure stability and a special resistance to loads.

Finish: matt lacquered in white and graphite grey.

Typology

Available in the free-standing and hanging variants, always with a 33 cm depth.

Frame in aluminium, section 1.5x1.5 cm, shelf 1.5 cm thick, available in the nominal lengths 60, 90 and 120 cm.

The end frames are equipped with an extruded aluminium pressure cap.

Minima 3.0 in the free-standing version comes in 6 heights: 42.5 cm, 79 cm, 115.5 cm, 152 cm, 188.5 cm and 225 cm; the first shelf is placed at 4.2 cm from the ground, while the uprights are equipped with adjustable feet in aluminium with a +/- 1.5 cm tolerance.

Inner height of compartments is 35 cm.

Minima 3.0 in the hanging version comes in four heights: 38 cm, 74.5 cm, 110 cm and 147.5 cm. Inner height of compartments is 35 cm.

Minima 3.0 is entirely made of 100% recyclable aluminium.

Cabinets

Elements made of MD-wood fibreboards, available in matt lacquered micro-goffered finish or in wood. They can be used in both the free-standing and in the hanging versions and rest inside the structure.

Available in the nominal lengths: 30, 60, 90 cm, height 35 cm and depth 33 cm, they are divided into the following categories:

- **Open units L30 cm:**
in MD- wood fibreboard, 8 mm thick, available in the matt lacquered micro-goffered finish in the following colour options: white, orange, avio blue, mustard yellow, green, dark red as well as in the natural wood variant, natural grey wood and natural black wood.
- **Open units with partition L30 cm:**
in MD- wood fibreboard, 8 mm thick, available in the natural wood variant, natural grey wood and natural black wood.
- **Units with flap opening door L60 and L90 cm:**
in MD- wood fibreboard, with variable thickness, available in the matt white lacquered micro-goffered finish as well

as in the natural black wood variant. Door equipped with downward compass opening, with retractable mechanism with a stainless steel cable, shock-absorbing system, adjustable in intensity and strength in the closing and opening phases.

- **Units with door L60 and L90 cm:**

In MD wood fibreboard, with variable thickness, available in the matt white lacquered micro-goffered finish as well as in the natural black wood variant. Door equipped with upward compass opening, with multi-position stop mechanism and braking function. This allows to keep the door in any opening position with a noiseless and gentle movement while closing.

- **Two-drawer units L60 and L90 cm:**

in MD- wood fibreboards, with variable thickness, available in the matt white lacquered micro-goffered finish as well as in the natural black wood variant. Double drawer equipped with push-pull system while opening, with totally-extractable guides.

MINIMA 3.0

Notes for the assembly

- A drawing of the composition is to be sent together with your order.
- For a proper use, we suggest to position the drawers at the bottom of the unit, or to fix the unit to the wall.
- To use this system (H152 - H188.5 - H225) as a room divider for home and work environments, we recommend to place two units side by side and fix them, so as to obtain a ground depth of 66 cm to ensure a proper stability.
- For a proper assembly, please carefully follow the instructions attached to the product.
- With configurations other than what proposed as well as for special compositions flanked at different heights, please ask the Sales Department to confirm feasibility.

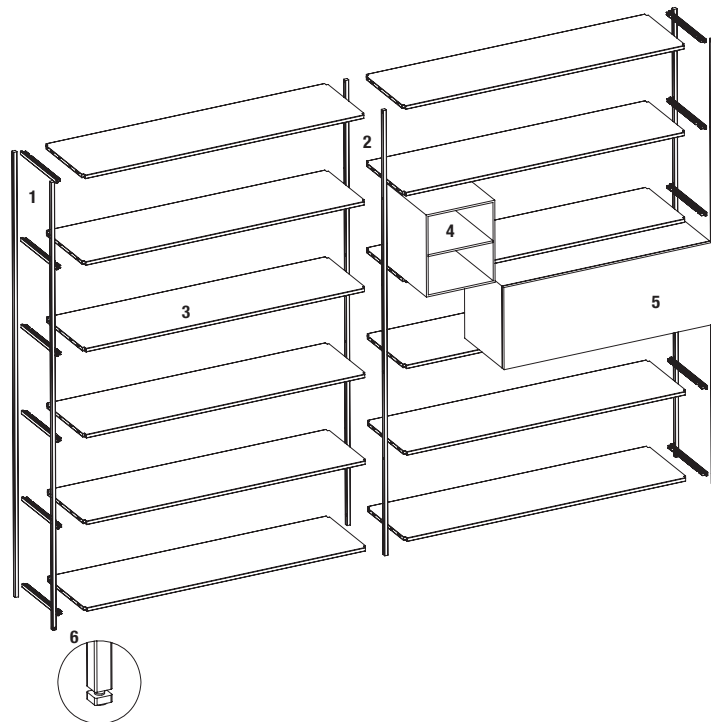

MINIMA 3.0 FREE-STANDING

- 1 free-standing end frame**, completed with fittings
- 2 free-standing intermediate frame**
- 3 shelf**
- 4 open cabinet with partition, L30**
- 5 cabinet**
- 6 adjustable feet**

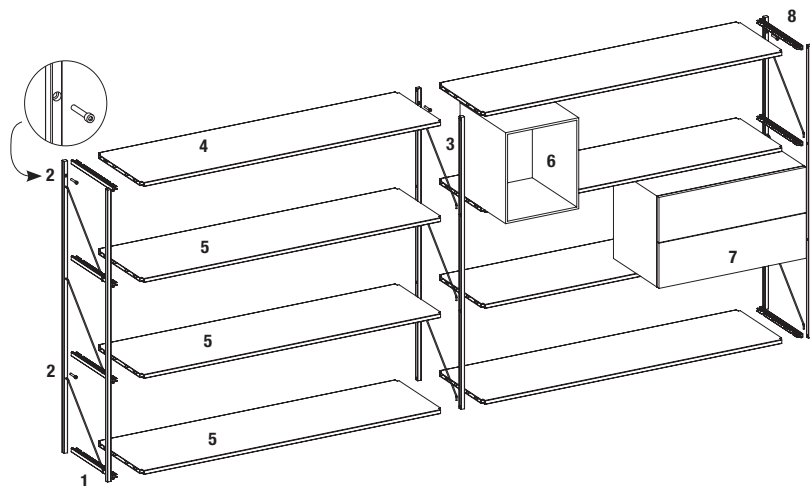

MINIMA 3.0 HANGING

- 1 hanging end frame (L)**, completed with fittings and tie rods
- 2 wall-fixing**
- 3 hanging intermediate frame** with tie rods
- 4 top shelf**
- 5 shelves** (base and intermediate)
- 6 open cabinet, L30**
- 7 two-drawer cabinet**
- 8 hanging end frame (R)**, completed with fittings and tie rods

MINIMA 3.0 units for composition

UPRIGHTS

Free-standing:
 H42.5
 H79
 H115.5
 H152
 H188.5
 H225

free-standing end frame, completed with fittings

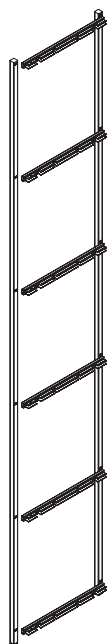

free-standing intermediate frame

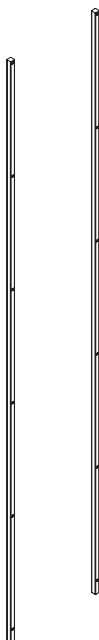

Hanging:
 H38
 H74.5
 H110
 H147.5

hanging end frame, (L or R) completed with fittings

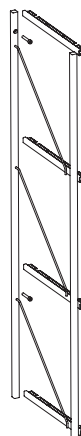

hanging intermediate frame

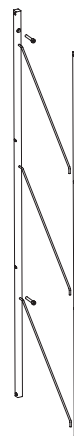

SHELVES L60/90/120 - D33

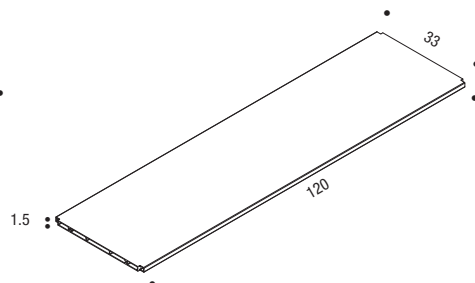
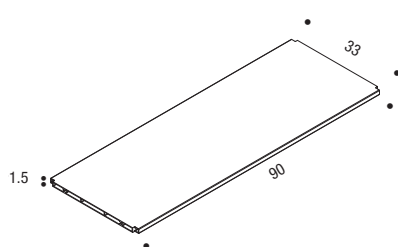
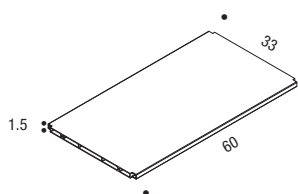

In the price list the shelving lengths are nominal and correspond to the inner usable space of the bookcase

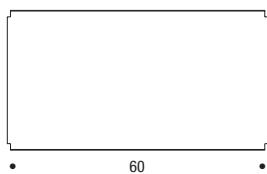

nominal size L60 cm
 real size L61.5 cm

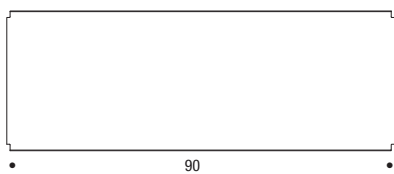

nominal size L90 cm
 real size L91.5 cm

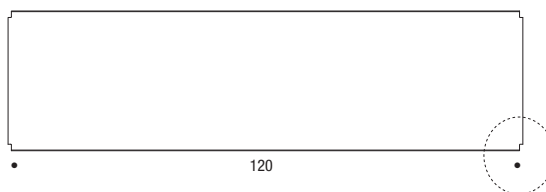

nominal size L120 cm
 real size L121.5 cm

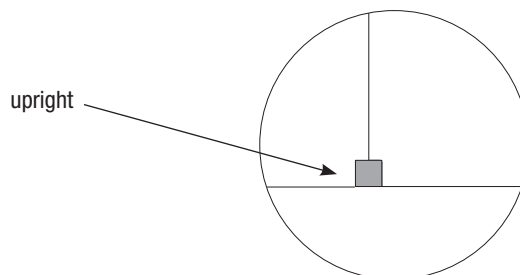

MINIMA 3.0 units for composition

CABINETS

In the price list the lengths and heights of the cabinets are nominal and correspond to the inner usable space of the bookcase

OPEN CABINET WITH PARTITION L30 - D33

sizes: nominal L30 - H35 cm
real L29.6 - H34.6 cm

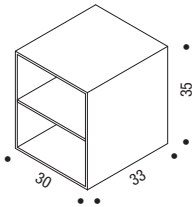

finishes:



OPEN CABINET L30 - D33

sizes: nominal L30 - H35 cm
real L29.6 - H34.6 cm

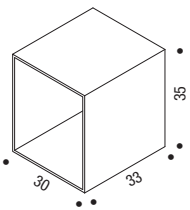

finishes:

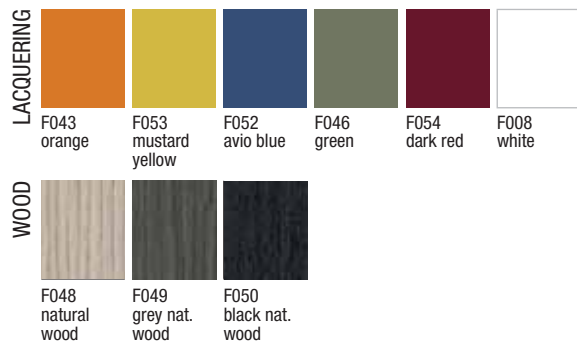

TWO-DRAWER CABINET L60/90 - D33

sizes: nominal L60 - H35 cm
real L59.6 - H34.6 cm

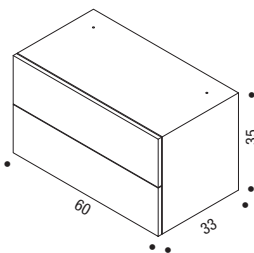

sizes: nominal L90 - H35 cm
real L89.6 - H34.6 cm

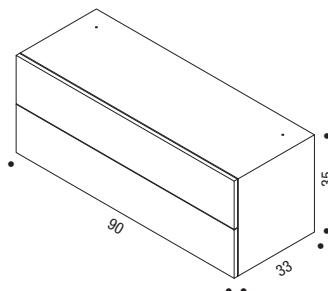

finishes:



CABINET WITH DOOR OR WITH FLAP OPENING DOOR L60/90 - D33

sizes: nominal L60 - H35 cm
real L59.6 - H34.6 cm

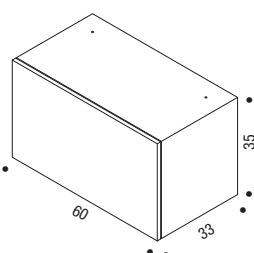

sizes: nominal L90 - H35 cm
real L89.6 - H34.6 cm

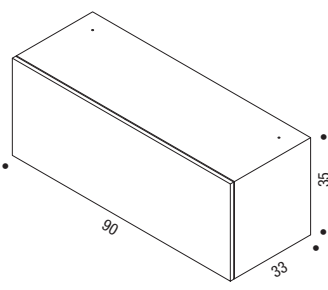

finishes:



MINIMA 3.0 abacus

FREE-STANDING

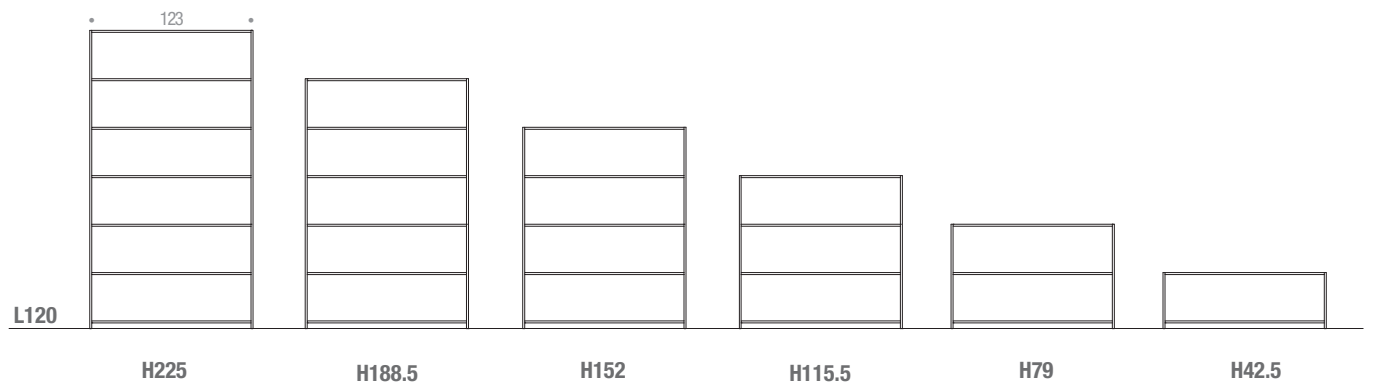
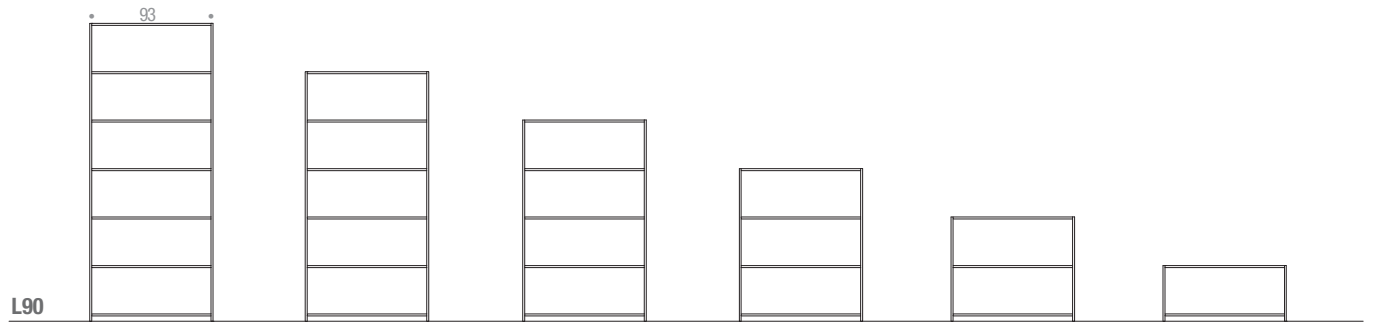
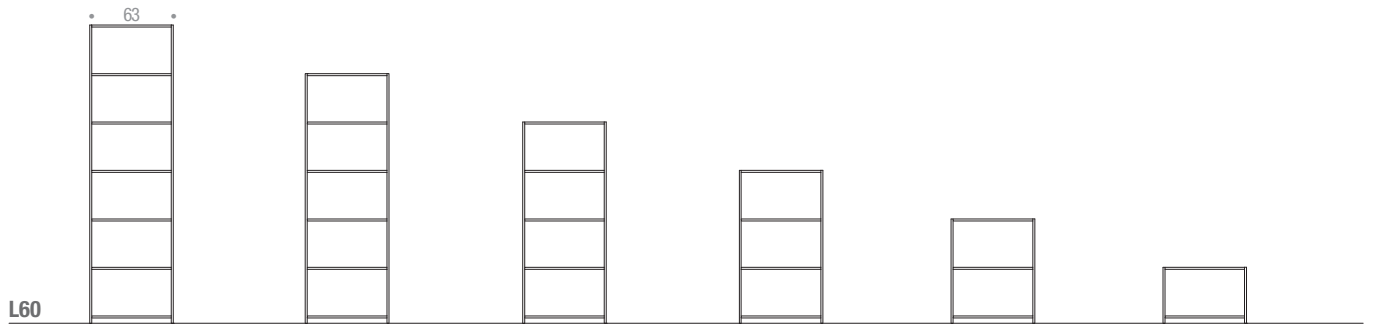

MINIMA 3.0 abacus

HANGING

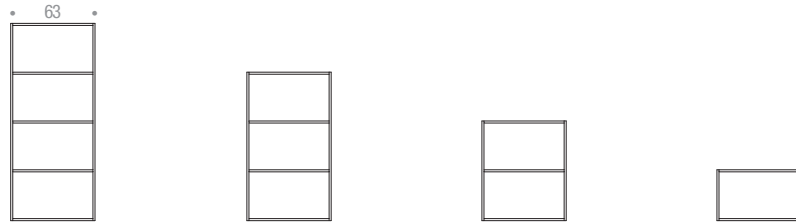

L60

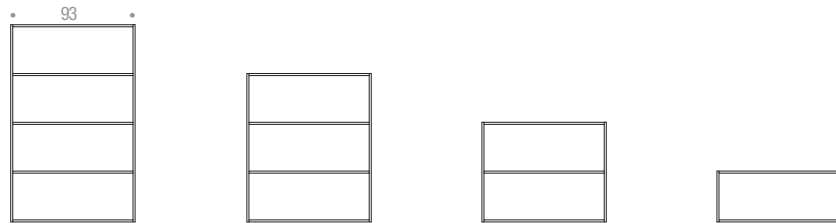

L90

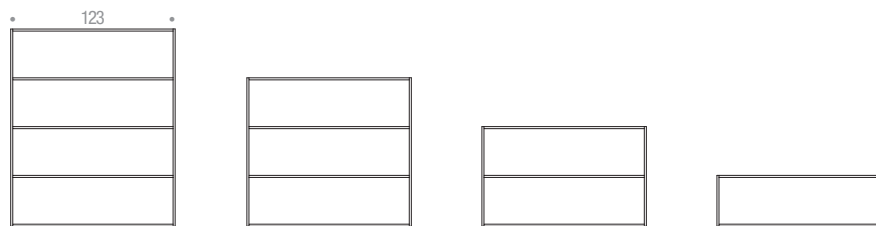

L120

H147.5

H110

H74.5

H38

MINIMA 3.0 abacus

FREE-STANDING

The Minima 3.0 system match the sizes of the Inmotion

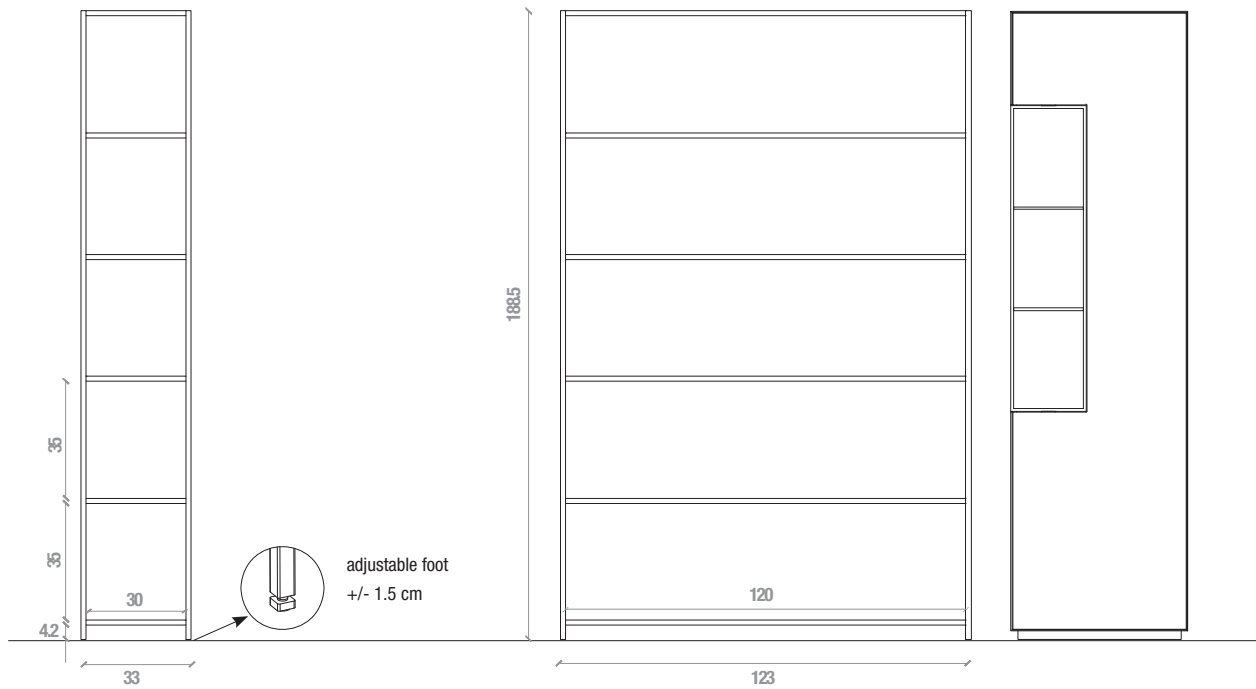

HANGING

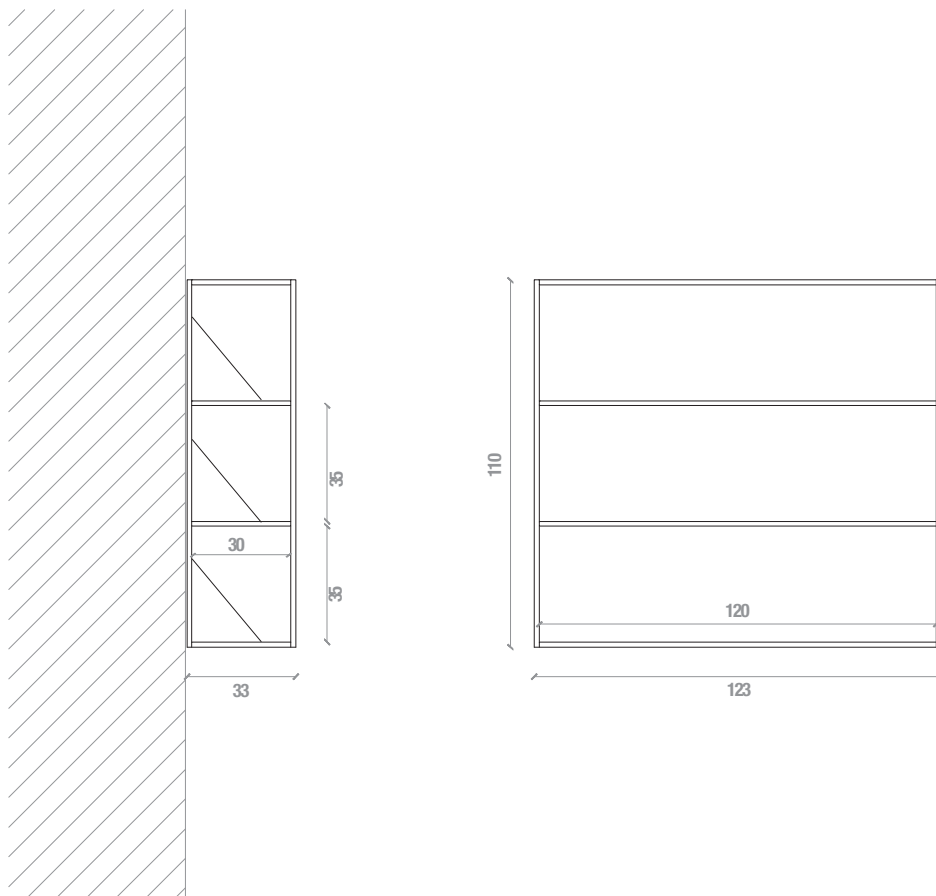

A drawing of the composition with the TV position is to be sent together with your order.

For ground variant only with 120 cm long shelving and in heights 115.5 cm, 152 cm, 188.5 cm and 225 cm, the bookcase can be set up to support a TV set.

With these variants, just one shelf can be removed, thus getting a 71.5x120 cm useful space, that is compatible for up to 46" TV sets (a size that may vary depending on brand and model).

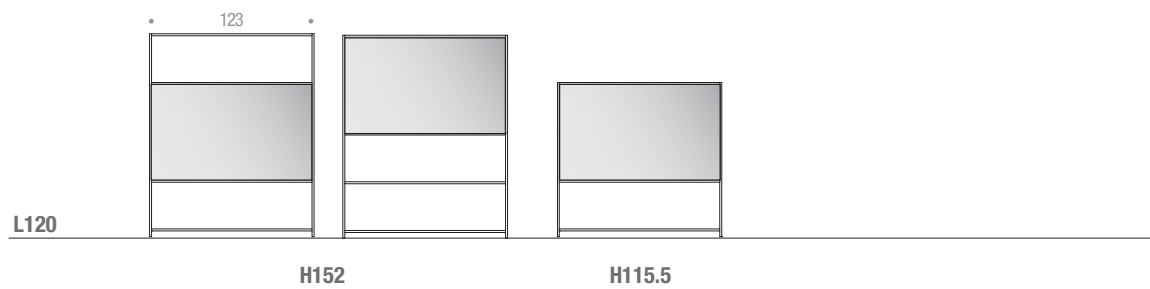
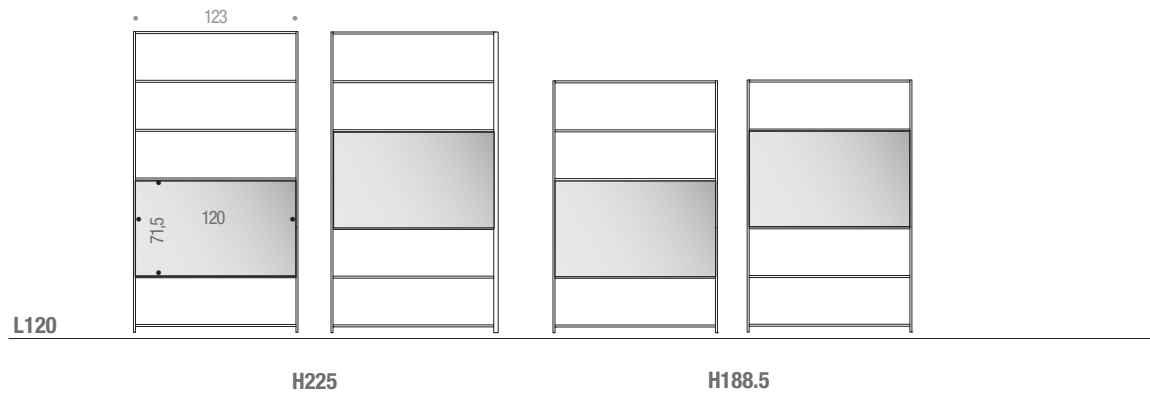

MINIMA 3.0 examples of compositions

HANGING

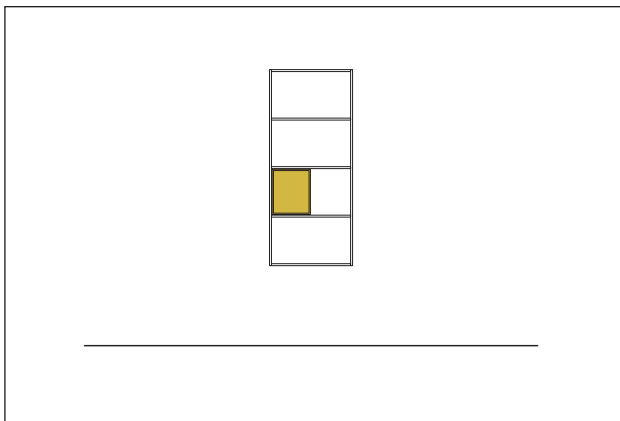

A - L63 X H147.5

- 1 hanging end frame L - H147.5
- 1 hanging end frame R - H147.5
- 1 top shelf L60
- 4 shelves L60
- 1 open cabinet, L30, lacquered

TOT

€ VAT excl.

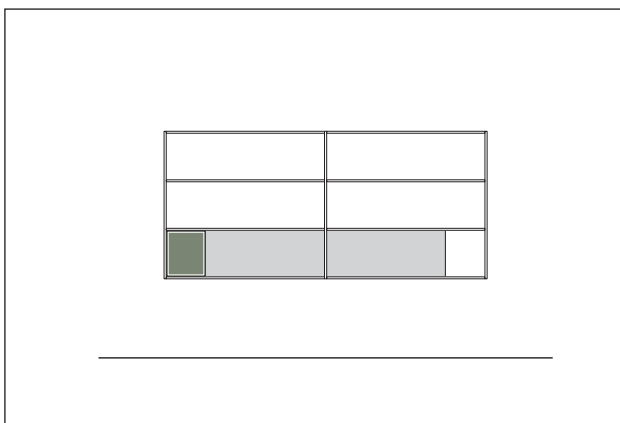

B - L244.5 X H110

- 1 hanging end frame L - H110
- 1 hanging end frame R - H110
- 1 hanging intermediate frame H110
- 2 top shelves L120
- 6 hanging shelves L120
- 1 open cabinet, L30, lacquered
- 2 cabinets with flap opening door, L90, matt white

TOT

€ VAT excl.

FREE-STANDING

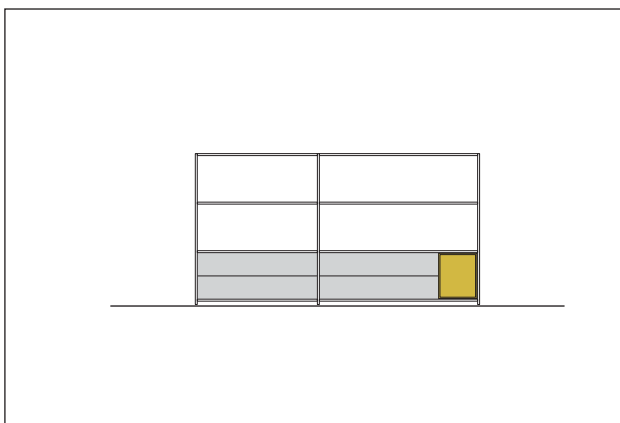

C - L214.5 X H115

- 2 free-standing end frames H115
- 1 free-standing intermediate frame H115
- 4 shelves L120
- 4 shelves L90
- 1 open cabinet, L30, lacquered
- 1 two-drawer cabinet, L60, matt white
- 1 two-drawer cabinet, L90, matt white

TOT

€ VAT excl.

MINIMA 3.0 examples of compositions

FREE-STANDING

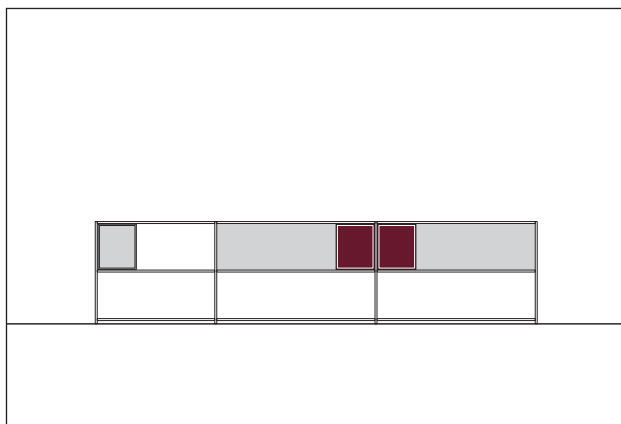

D - L336 X H79

- 2 free-standing end frames H79
- 2 free-standing intermediate frames H79
- 6 shelves L120
- 3 shelves L90
- 3 open cabinets, L30, lacquered
- 2 cabinets with flap opening door, L90, matt white

TOT € VAT excl.

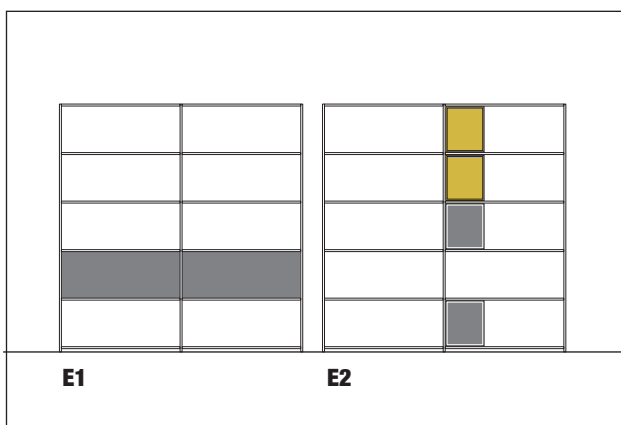

E1 - L184.5 X H188.5

- 2 free-standing end frames H188.5
- 1 free-standing intermediate frame H188.5
- 12 shelves L90
- 2 two-drawer cabinets, L90, black natural wood

TOT € VAT excl.

E2 - L184.5 X H188.5

- 2 free-standing end frames H188.5
- 1 free-standing intermediate frame H188.5
- 12 shelves L90
- 2 open cabinets, L30, lacquered
- 2 open cabinets, L30, natural wood

TOT € VAT excl.

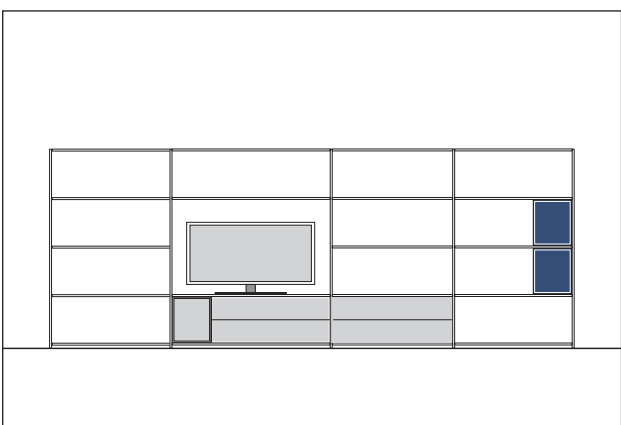

F - L347.5 X H152

- 2 free-standing end frames H152
- 3 free-standing intermediate frames H152
- 4 shelves L120
- 15 shelves L90
- 2 two-drawer cabinets, L90, white lacquered
- 3 open cabinets, L30, lacquered

TOT € VAT excl.

MINIMA 3.0 examples of compositions

FREE-STANDING

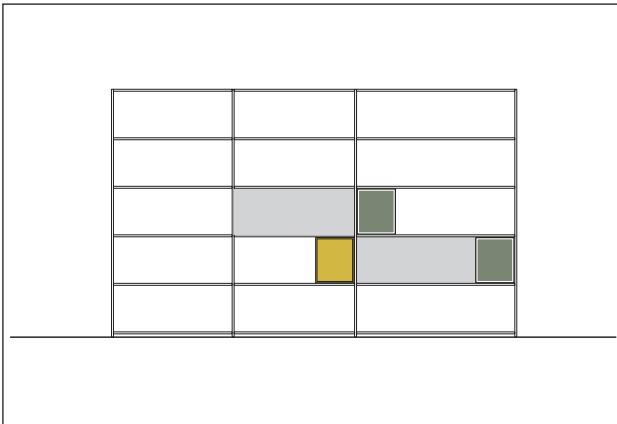

G - L306 X H188.5

- 2 free-standing end frames H188.5
- 2 free-standing intermediate frames H188.5
- 12 shelves L90
- 6 shelves L120
- 2 cabinets with flap opening door, L90, matt white
- 3 open cabinets, L30, lacquered

TOT € VAT excl.

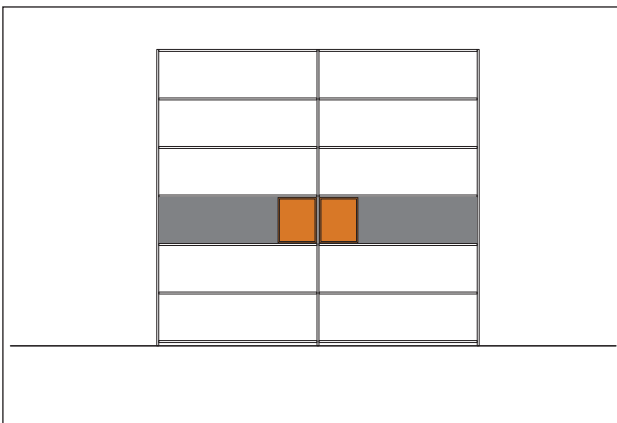

H - L244.5 X H225

- 2 free-standing end frames H225
- 1 free-standing intermediate frame H225
- 14 shelves L120
- 2 open cabinets, L30, lacquered
- 2 cabinets with flap opening door, L90, black natural wood

TOT € VAT excl.

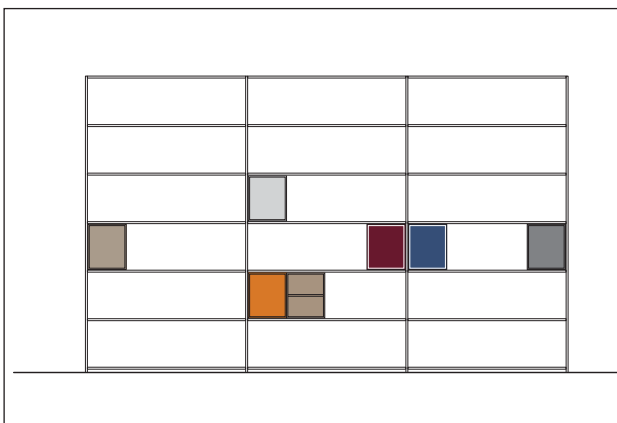

I - L366 X H225

- 2 free-standing end frames H225
- 2 free-standing intermediate frames H225
- 21 shelves L120
- 4 open cabinets, L30, lacquered
- 2 open cabinets, L30, natural wood
- 1 open cabinet, L30, natural wood with partition

TOT € VAT excl.
